

Article number: 12308200060110

Description: KLEE-coil 308 200 060.110  
M6 Hardened/zinc-plated steel with hexagon

## Measures

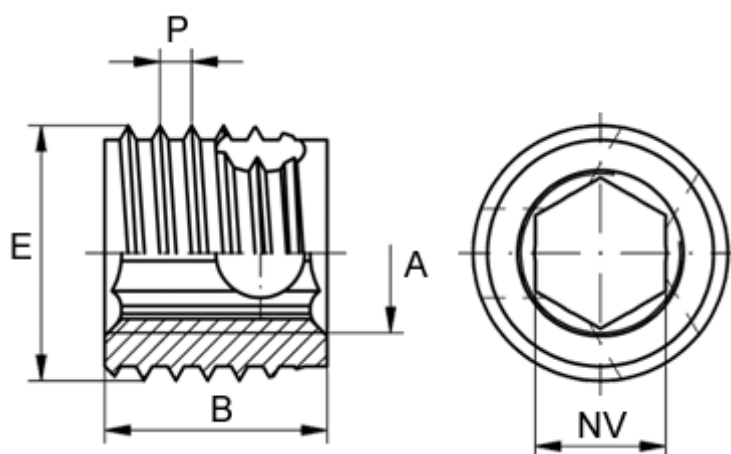

Female thread A	= M6
Length B	= 12
Male thread E	= 10
Min hole depth blind hole	= 15
Min material thickness	= 12
sw	= -
Thread pitch P	= 1.25
Type	= 308 200 060 ...